

OmniRoam

Omni-Directional Mobile 5G/WiFi/GPS Antenna

Designed by WAVEFORM in the USA

SKU: ANT-M-SM-xxx



Multiple Variants

Vary by Cellular, Wi-Fi, and GPS antenna quantities



4G and 5G Cellular Support



Up to 6.9 dBi Cellular Gain



IP68 Weather Rating



SMA-Type Connectors

SMA for Cellular & GPS | RP-SMA for Wi-Fi



Physical Specifications:



Antenna

Color	Black
Material	ASA (UV Stable)
Dimensions (ht. x diam.)	5.1 x Ø20.0 cm (1.99 x Ø7.88 in)
Net Weight	0.82 kg (1.8 lbs)

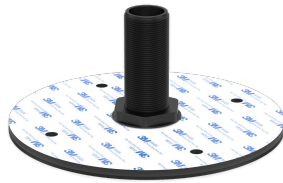

Spigot Mount

Color	Black
Materials	ASA (UV Stable)
Mount Dims. (ht. x diam.)	9.4 x Ø20.0 cm (3.70 x Ø7.88 in)
Spigot Dims. (ht. x diam.)	8.0 x Ø3.2 cm (3.15 x Ø1.26 in)
Nut Spec.	M25 Flange Nut
Washer Spec.	M25 Lock Washer
Adhesive Type	3M 9448A
Net Weight	0.18 kg (0.4 lbs)

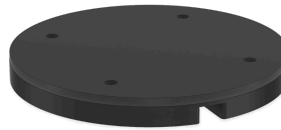

Magnetic Mount

Color	Black
Material	ASA (UV Stable)
Mount Dims. (ht. x diam.)	2.7 x Ø20.0 cm (1.08 x Ø7.88 in)
Magnet Dims. (ht. x diam.)	0.2 x Ø3.0 cm (0.08 x Ø1.18 in)
Magnet Specification	9xN38 Neodymium
Grip Pad	30 deg Silicone
Net Weight	0.39 kg (0.9 lbs)

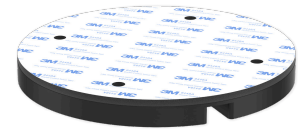

Adhesive Mount

Color	Black
Material	ASA (UV Stable)
Mount Dims. (ht. x diam.)	2.6 x Ø20.0 cm (1.04 x Ø7.88 in)
Adhesive Type	3M 9448A
Net Weight	0.18 kg (0.4 lbs)



Assembly Tools:

Allen Wrench	Material	Nickel-Plated Iron
	Spec.	Size-4mm
Bolts*	Material	316 Stainless Steel
	Spec.	M4 x 12mm

*Includes 1x spare



WAVEFORM

3411 W. Lake Center Drive,
Santa Ana, CA 92704

www.waveform.com
1-800-761-3041

OmniRoam

Omni-Directional Mobile 5G/WiFi/GPS Antenna

Designed by WAVEFORM in the USA

Cellular Specifications:

Cellular Antenna:

Frequency Range	600 - 900 MHz	1700 - 2700 MHz	3500 - 4200 MHz	5000 - 6000 MHz
Gain (Average Peak)	4.2 dBi ± 1.1 dB	5.4 dBi ± 0.9 dB	6.9 dBi ± 0.4 dB	5.7 dBi ± 0.7 dB
Azimuth Beamwidth	360 deg [Omni-Directional]			
Elevation Beamwidth	122 ± 19 deg	149 ± 19 deg	180 ± 3 deg	178 ± 12 deg
VSWR	≤ 2.7	≤ 1.5	≤ 1.3	≤ 1.6
MIMO Isolation (Peak)	19.6 dB	29.4 dB	43.6 dB	36.4 dB
Efficiency (Peak)	48 %	51 %	55 %	43 %
Input Impedance	50 Ω			
Power Rating	25 W (Peak)			
Polarization	Vertical			
Antenna Type	Omni-Directional			

Cellular Cable:

Connector	Type	SMA-Male
	Diam.	7.9 mm (0.31 in)
	Type	RS31
Cable	Color	Black
	Jacket	TPE
	Diam.	3.3 mm (0.13 in)
	Length	2.0 m (6.6 ft)
	Bend Radius	15 mm (0.6 in) [Repeat] 5 mm (0.2 in) [Install]
	Quantity	0 to 4x [Varies by Model]

Wi-Fi Specifications:

Wi-Fi Antenna:

Frequency Range	2.4 GHz	5.0 GHz	6.0 GHz
Gain (Average Peak)	5.9 dBi ± 1.1 dB	5.8 dBi ± 0.5 dB	3.3 dBi ± 0.3 dB
Azimuth Beamwidth	360 deg [Omni-Directional]		
Elevation Beamwidth	163 ± 2 deg	165 ± 15 deg	155 ± 5 deg
VSWR	≤ 1.3	≤ 1.7	≤ 1.9
Efficiency (Peak)	46 %	37 %	33 %
Input Impedance	50 Ω		
Power Rating	25 W (Peak)		
Polarization	Vertical		
Antenna Type	Omni-Directional		

Wi-Fi Cable:

Connector	Type	RP-SMA-Male
	Diam.	7.9 mm (0.31 in)
	Type	RS31
Cable	Color	Black
	Jacket	TPE
	Diam.	3.3 mm (0.13 in)
	Length	2.0 m (6.6 ft)
	Bend Radius	15 mm (0.6 in) [Repeat] 5 mm (0.2 in) [Install]
	Quantity	0 to 4x [Varies by Model]

GPS Specifications:

GPS Antenna:

Frequency Range	1575 - 1610 MHz
Gain (Average Peak)	28 dBi ± 5 dB
VSWR	≤ 2.0
Input Impedance	50 Ω
Power Rating	0.13 W (Peak)
Voltage (Operation)	3.3 V
Current (Operation)	< 20 mA
Polarization	RHCP
Antenna Type	Omni-Directional
GNSS Band Support	L1 [GPS], G1 [GNSS], E1 [GALILEO]

GPS Cable:

Connector	Type	SMA-Male
	Diam.	7.9 mm (0.31 in)
	Type	RG174
Cable	Color	Black
	Jacket	TPE
	Diam.	2.8 mm (0.11 in)
	Length	2.0 m (6.6 ft)
	Bend Radius	15 mm (0.6 in) [Repeat] 5 mm (0.2 in) [Install]
	Quantity	0 to 1x [Varies by Model]

Other Specifications:

Environmental:

Protection Class	IP68
Impact Rating	IK10
Rated Wind Velocity*	225 kph (180 mph)
UV Rated?	Yes
Operating Temperature	-40 to +85 deg C (-40 to +185 deg F)

* May be lower for Adhesive & Magnetic Mounts, depending on mounting surface.



WAVEFORM

3411 W. Lake Center Drive,
Santa Ana, CA 92704

www.waveform.com
1-800-761-3041

OmniRoam

Omni-Directional Mobile 5G/WiFi/GPS Antenna

Designed by WAVEFORM in the USA

Cellular Antenna Radiation Patterns:

Azimuth Plane "Top-down view"

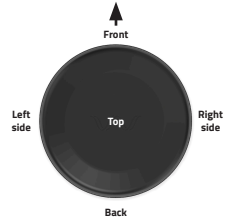

600-900 MHz

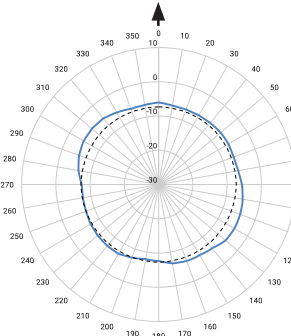

1700-2700 MHz

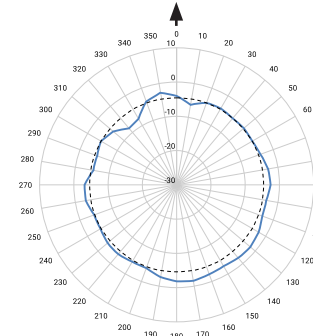

3500-4200 MHz

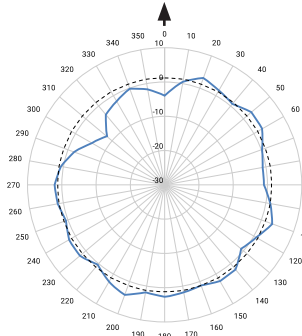

5000-6000 MHz

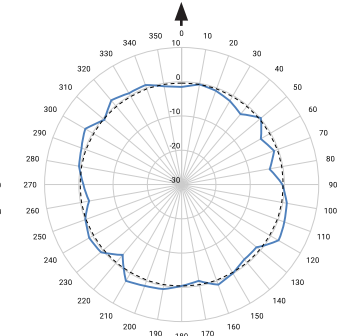

Elevation Plane "Side-on view"

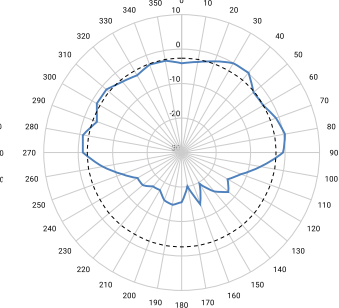
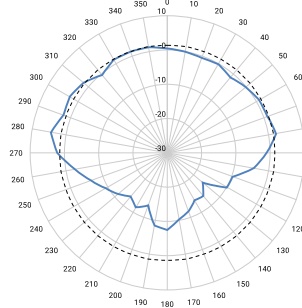
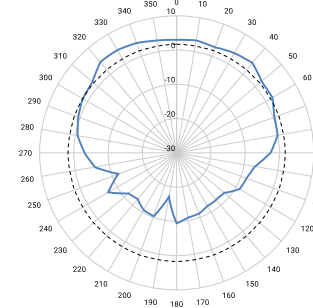
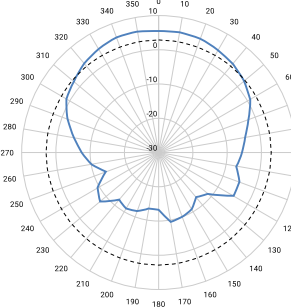

Cellular Antenna Peak Gain (dBi) by Frequency (Mhz)

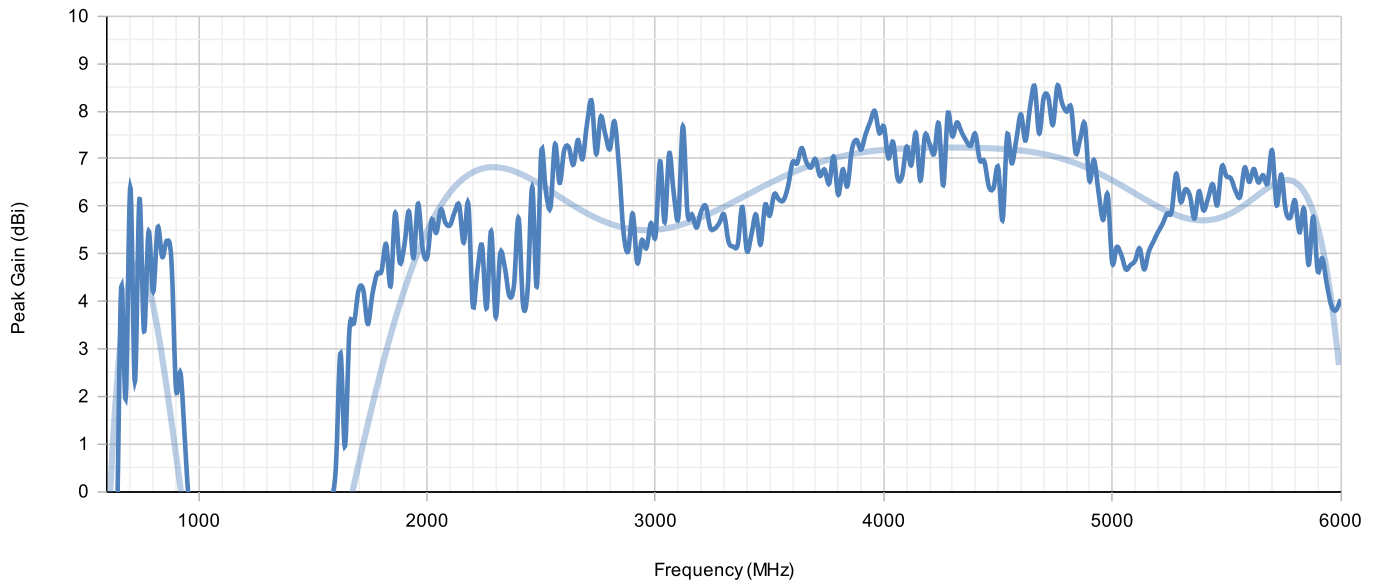

WAVEFORM

3411 W. Lake Center Drive,
Santa Ana, CA 92704

www.waveform.com
1-800-761-3041

OmniRoam

Omni-Directional Mobile 5G/WiFi/GPS Antenna

Designed by WAVEFORM in the USA

Wi-Fi Antenna Radiation Patterns:

Azimuth Plane
"Top-down view"

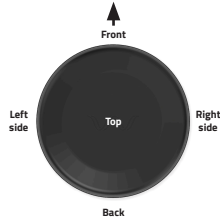

2400 MHz

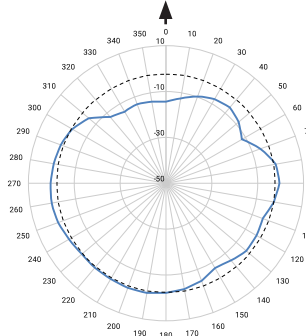

5000 MHz

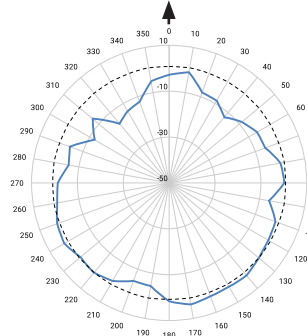

6000 MHz

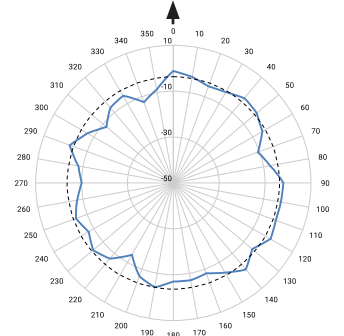

Elevation Plane
"Side-on view"

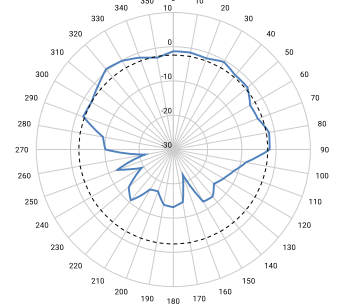
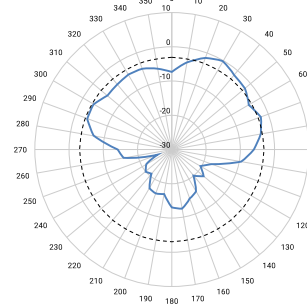
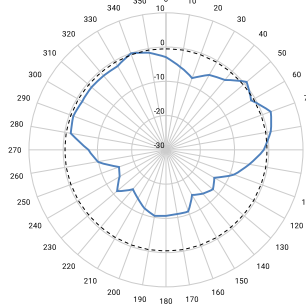
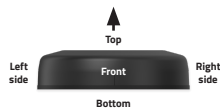

Wi-Fi Antenna Peak Gain (dBi) by Frequency (MHz)

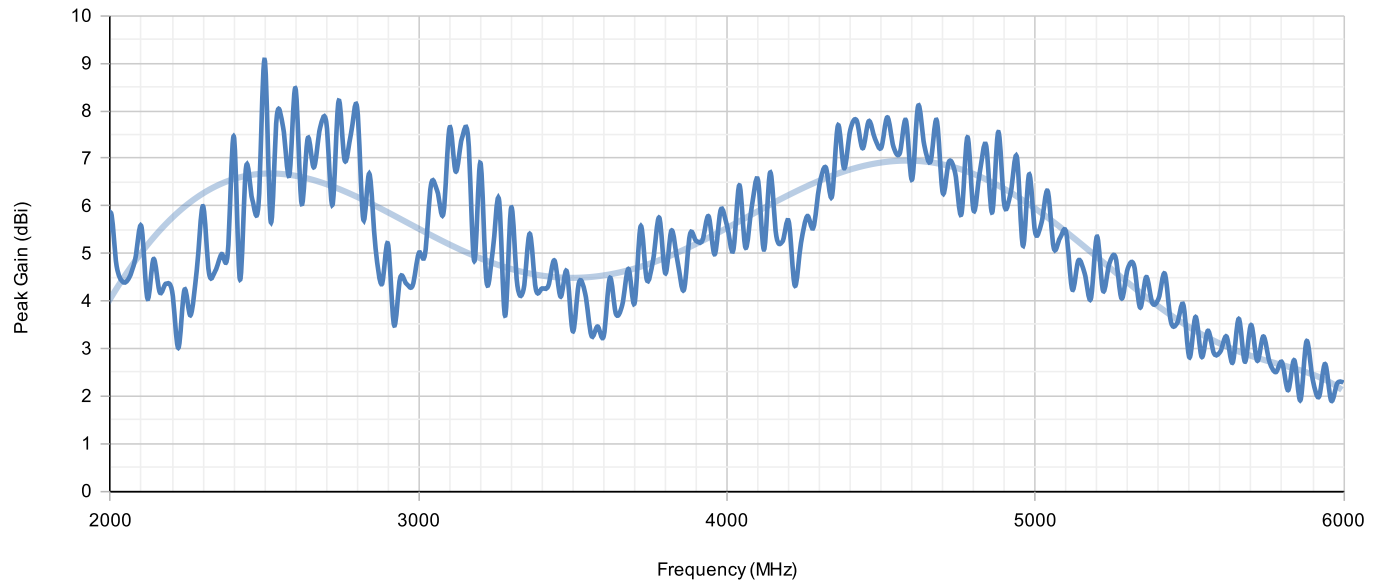

WAVEFORM

3411 W. Lake Center Drive,
Santa Ana, CA 92704

www.waveform.com
1-800-761-3041

OmniRoam

Omni-Directional Mobile 5G/WiFi/GPS Antenna

Designed by WAVEFORM in the USA

Dimensions:

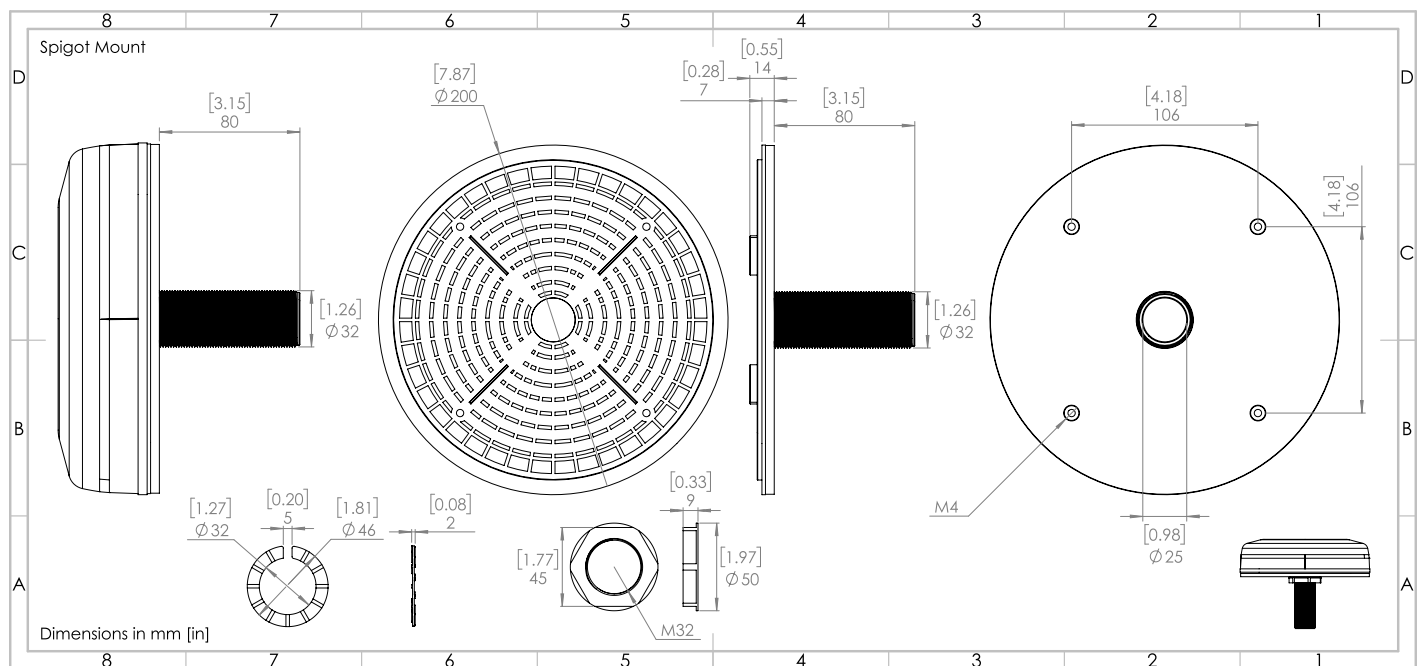
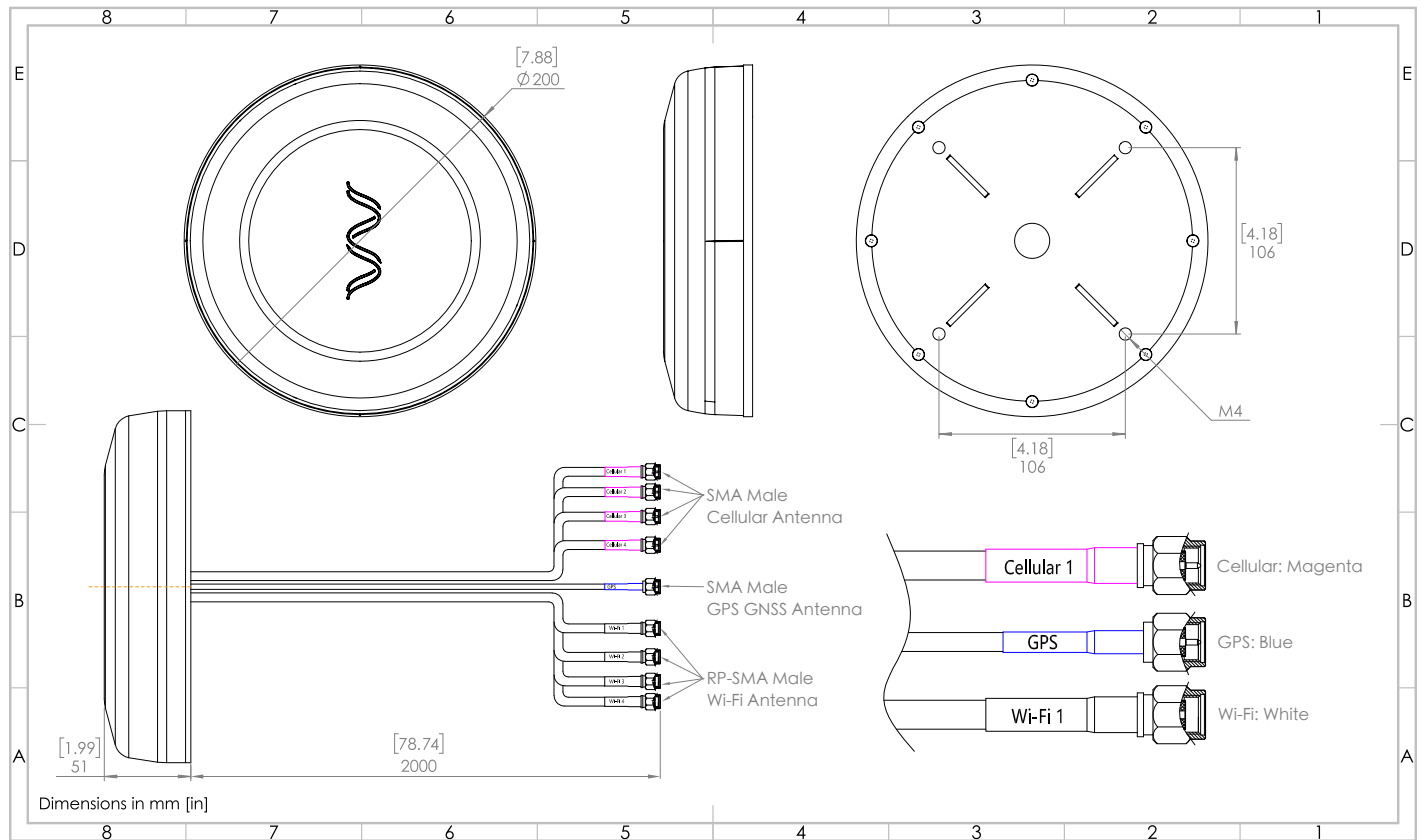

OmniRoam

Omni-Directional Mobile 5G/WiFi/GPS Antenna

Designed by WAVEFORM in the USA

Dimensions:

